

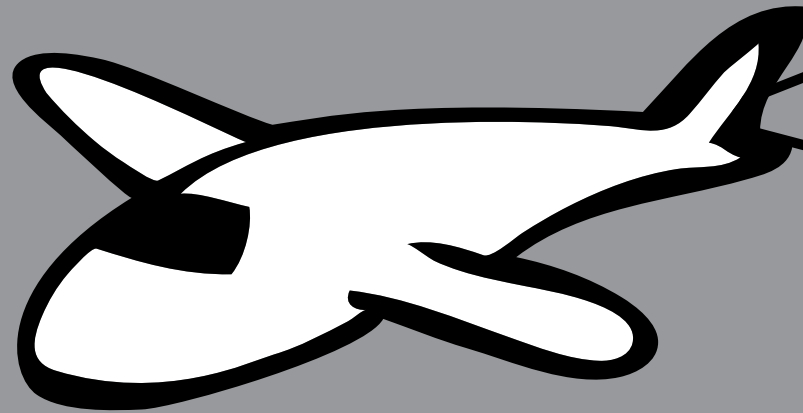

**Energy Management and Building Automation**

**InduSoft<sup>®</sup>**

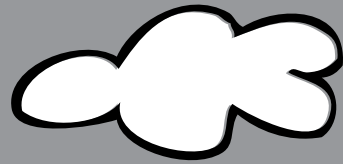
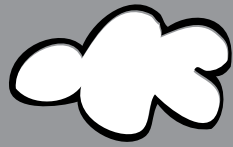

## Building Automation Solutions with InduSoft Web Studio

As energy costs rise, new infrastructure projects are undertaken, and older buildings are retrofitted to new standards, the building automation industry increasingly turns to SCADA solutions to keep pace with technology.

InduSoft Web Studio has proven through countless applications designed for building automation that it packs in all the tools and functions necessary to monitor and control everything from schools across whole districts, hospitals, pharmaceutical warehouses, and even personal homes. InduSoft Web Studio is non-proprietary, and can communicate with devices from nearly every vendor using the over 240 built in native drivers (Including BACnet and Modbus). The software also supports OPC DA, OPC UA, and OPC .NET 3.0 connectivity.



# Trends In Building Automation

## *Rising Energy Costs are Changing the Way We Build*

With the increase in energy costs and the corresponding need to reduce energy consumption, the demand for buildings to speak to us and to tell us how best to maintain them has never been greater. Facilities are becoming increasingly connected to utilities, and interest in renewable energy options continues to rise. This has forced companies to have to evaluate what equipment they have on their facilities, what the real costs behind operating that equipment may be, and what changes can be made in the operation to curb energy use and make the most efficient systems.

In addition, there is a growing global shift toward buildings that have a lower carbon footprint, or buildings that can even become carbon neutral. Accomplishing this requires a careful collection of data that can be used to quantify energy use and expenditures.

## *A Demand for More Control*

Scheduling, is a function that no good building automation system can be complete without. To accomplish the goals of using energy efficiently, scheduling tools have become increasingly critical. InduSoft Web Studio includes the scheduling tools necessary to reduce energy use during off-peak hours, night, or even account for variables in scheduling such as holidays or events.

## *Increased Security Concerns*

Addressing the increasing complexity of security management of these systems in real time is a growing challenge. InduSoft Web Studio provides tools that allow connections to barcode and RFID chip readers, enabling door badge systems and other methods of user authentication. The software also supports user accounts and varied levels of user access, which makes it possible to track doors and security systems, and even the traffic of personnel that comes in and out of the facility.

## *A Fully Integrated Solution*

InduSoft Web Studio is being used to relay important information about energy management, optimized operating conditions, and improved asset utilization. All too often people think of building systems as just heating, ventilation and air conditioning (HVAC) systems, but a truly integrated system covers much more. Integrated Systems have the ability—with a single interface—to be able to manage, monitor and operate all aspects of the building including heating and air conditioning, security and surveillance, lighting, fire and safety systems, as well as other building equipment.

## *A Push Toward Cloud-Based Connectivity*

InduSoft has long provided the functionality to configure web-based applications, and applications that can send alarms and other data directly to e-mail or via SMS. Smartphones are increasingly popular ways to visualize data. InduSoft Web Studio provides three different types of thin client options that will allow users to create building automation systems that can be viewed or managed not only in a central control room, but from every corner of the facility.

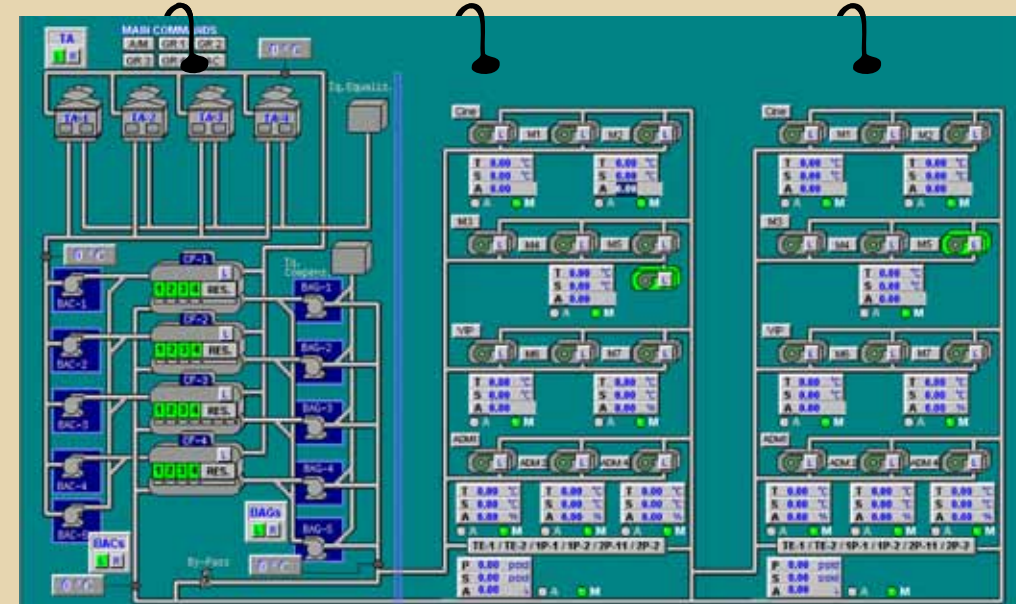

## An Easy Solution for a Complex System

The need for simple tools for automation that allow you to deploy highly redundant control systems to mobile devices has never been greater. These control systems also provide the flexibility required for a master plan for building automation that involves a whole building approach for energy efficiency, and to comply with government regulations.

The InduSoft Web Studio commitments for interoperability with such systems as lighting controls, HVAC mechanical equipment, security and access control systems, fire and life safety systems, and many other kinds of systems are the basis for a long-time support of the BACnet and Modbus protocols.

InduSoft Web Studio has drivers for BACnet and Modbus that will allow a user on any Microsoft Platform from Windows Embedded to Windows 7 to connect to lighting, HVAC, security, and other systems and devices from multiple vendors that can be attached to a network. This capability enables single-seat, global control, and access to all connected building control systems.

For logging and retrieving data, InduSoft has developed a patented method of connecting with any SQL database that goes a long way in making the acquisition and retrieval of this data a very simplified process. The purpose of our software is not that you be a programmer or have extensive familiarity with databases – we provide you with a platform that makes it easy to acquire the data, and then visualize and interpret it through the system.

As building automation continues to evolve, it must constantly work with legacy systems that are not typically replaced every five or fewer years. For example, a building's chillers often perform for 30 years. InduSoft Web Studio understands the need to constantly work with legacy systems while evolving to newer technologies. InduSoft Web Studio maintains this balance by providing seamless integration with new releases of its product. An application written in InduSoft Web Studio V1.0 can be upgraded to the latest release InduSoft Web Studio v7.0 without changes. It is completely compatible, providing users with new technology while still maintaining compatibility with legacy systems.

With the evolution of Wireless Control Networks for Building Automation, Indusoft Web Studio is poised with its strong mobile offering to provide flexibility for building managers to virtually connect to any building system using a mobile or wireless device such as cell phones or tablet computers. Integrating controls saves on cost, as operators are better able to view equipment performance and be more proactively involved in preventative maintenance. With the ability to reduce energy consumption,

InduSoft Web Studio helps to position buildings to go completely green. With regulations evolving in this area, being proactive in creating a single interface that allows viewing from mobile devices, the Web and a control interface will provide an unprecedented level of real-time monitoring and control of heating and air conditioning, security and surveillance, lighting, fire and safety systems as well as other building equipment.

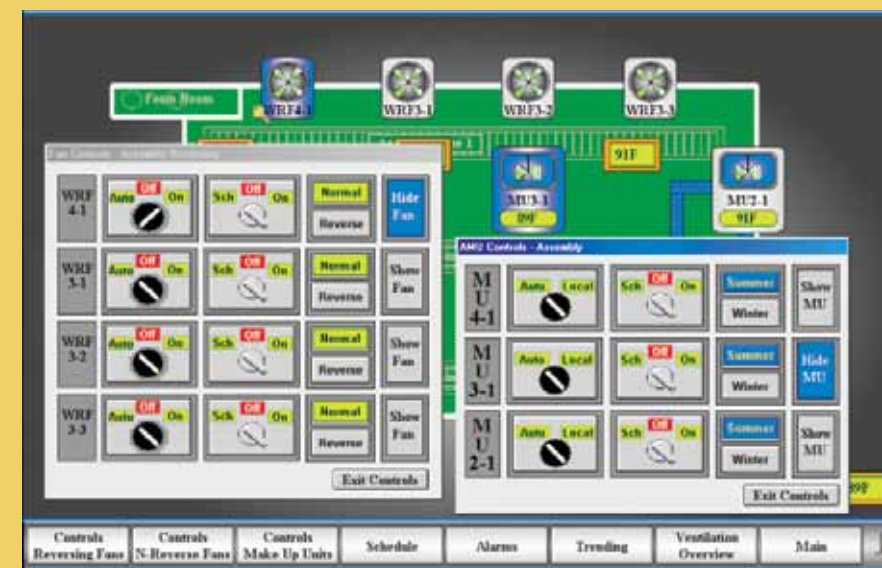
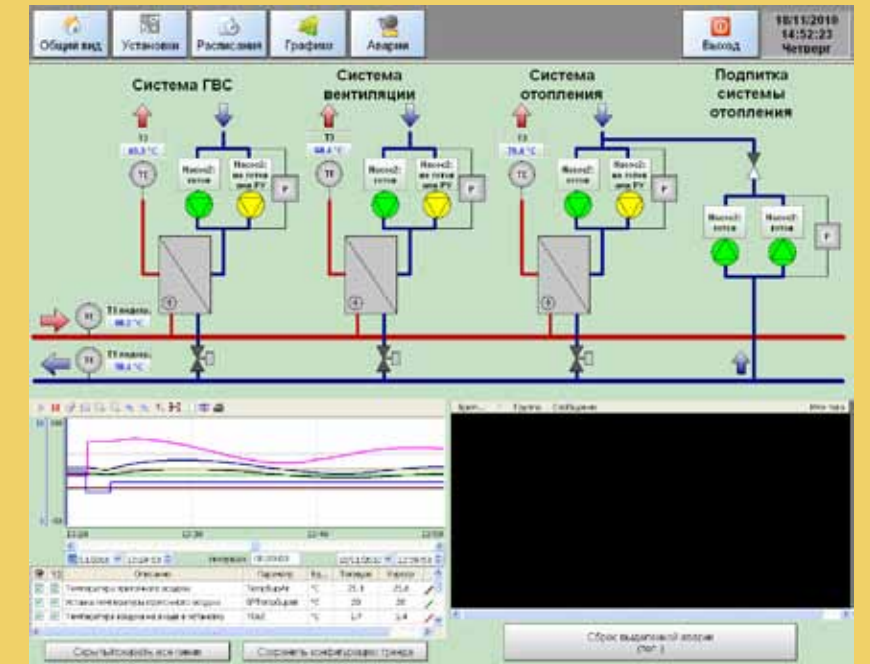

## Case Studies in Building Automation with InduSoft Web Studio

InduSoft Web Studio has been used worldwide for building automation projects ranging from single family homes to entire school districts. We encourage you to read the full case studies online at [www.InduSoft.com](http://www.InduSoft.com), or request printed versions from your local InduSoft representative. Here is a brief overview of some of the applications InduSoft Web Studio has been used to create:

### **Retel Neuhausen AG Helps Merck & Cie Meeting New, Tight Standards:**

Retel Neuhausen AG was charged with developing an application that would help a Merck and Cie plant meet tight government regulations. Under internationally sanctioned guidelines, not only must process data be recorded, but environmental conditions of rooms and storage and production facilities must be monitored as well. In addition, security is required that will allow record-keeping of user access to equipment and materials. This requires traceability features, such as individual user access with protected usernames and passwords, and the verification of eSignatures. InduSoft Web Studio was used to develop an application that met all international regulations related to the environmental quality of this pharmaceutical production facility.

### **A Building Management System for Hospitals in Russia:**

The Central Clinical Hospital of the Federal Custom Service, located in Moscow, contracted with the Russian company First Mile to develop a building management system that would meet all the requirements of a state-of-the-art medical facility. First Mile created a building management system for them using InduSoft Web Studio for a powerful medical facility automation application. First Mile constructed an application with a minimal number of screens by using key technology and VBScripting native to InduSoft Web Studio. The finished product monitors each of the engineering functions, and collects information on the ventilation system, the air chiller and HVAC, the temperature, and air supply. The issue of the hot water supply was also a major aspect of the design of the system. The water, distributed by the largest supplier in Moscow, Monsenergo, required quick changes in temperature and pressure.

### **Paulista Shopping Mall:**

The upscale Paulista shopping mall in São Paulo, Brazil uses an intuitive building automation interface to control all phases of operation using InduSoft Web Studio. The graphic displays allow ease of use that allows for reduced operator training costs, and slow network speeds have been overcome thanks to communication optimization by InduSoft. This application could be designed easily and efficiently thanks to the tools included for quick development and rapid deployment.

### **Dosapac S.A. using technology to set the bar in school building automation systems:**

Over 75% of the schools in Portugal's secondary public school network are facilities that were built before 1968. Parque Escolar was established in Portugal as a government backed corporation tasked with modernizing Portuguese school buildings. Along with new fixtures and flooring came new challenges, such as how to automate vital functions. Everything from energy supplies and consumption to the climate control needed to be monitored in order to protect the quality of the environment for students and faculty.

Using InduSoft, Dosapac S.A. was able to create a new standard for building management software for buildings in Portugal. By contributing to Parque Escolar, they are able to help create state of the art school buildings throughout Europe.

### **American Water Heater:**

Most of us take hot running water for granted and give no thought whatsoever to what life might be like without it. American Water Heater Company is one of the leaders in the contingent that makes that simple luxury a reality. Using the drag and-drop paradigm, American Water Heater designed an application to monitor and control the ventilation system in their plant in weeks rather than months. Manufacturing engineers successfully coupled the ventilation system to 17 temperature systems throughout the plant. Within a few months, more than 100 different control points will also be monitored, enabling the coordinated management of production rates and downtime.

**InduSoft Web Studio HMI Software Used to Automate Home:** John Rasmussen, a homeowner in Salt Lake City, Utah, was unable to find a suitable home automation system that could perform more than just a few functions and would also be easy to integrate, so he built his own, using the industrial-based InduSoft Web Studio HMI/SCADA software and a programmable logic controller (PLC). Not only did Rasmussen find the software flexible, but also affordable. "With industrial systems like the InduSoft Web Studio software and a PLC, I can connect valves, pumps, sensors, switches and video quite easily," he says. "With traditional home automation products, the choices are much more limited. I would have to buy separate systems for security, heating/cooling, and audio, and they would not work together. For the zone heating alone, I would have needed three commercial controllers with limited functionality, and all of them were sold separately!"

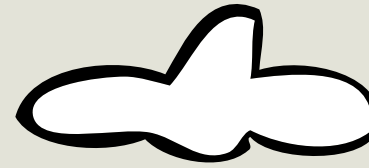
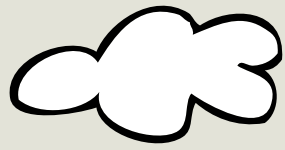

## The Growing Need for Security in Building Automation

Security plays a vital role in many recent building automation projects, and there is increasing demand for an all-in-one tool that has built-in capabilities for building automation and security. Many public buildings must meet security standards, as well as schools, detention centers, hospitals, and even manufacturing or storing food and beverages and pharmaceuticals. InduSoft has a unique insight in the security market, and has proven to be a software powerful and reliable enough for detention centers and prisons.

### ***Juvenile Facility Improves Security Measures Using InduSoft Web Studio to Run Multiple Systems:***

The Eaton County Youth Services juvenile treatment and detention facility is in Charlotte, Michigan. This 24 bed facility houses young people deemed to have “behavioral challenges.” To reduce problems with the detainees and monitor their movements, security personnel used an aging computer system to listen to sounds in each detainee’s room and other areas of the facility, so they could identify abnormal sounds, movements or activities. This system was replaced by a system designed with InduSoft Web Studio. Workers can monitor the status of doors, control access to the building, and listen to rooms from the control station.

### ***Sierra detention Systems – Helping to ensure the security of a community:***

Whether we like it or not, correctional facilities are a fact of civilized life. And as prison systems have evolved to become more sophisticated and secure, policies and procedures have evolved to ensure that security. Nobody is more aware of this evolution than Sierra Detention Systems, where InduSoft Web Studio has been used to develop a system that controls over 2,000 devices and 35 HMI screens. Using this system, the Adams County Sheriff’s office in Colorado can monitor every camera on the facility, and control the entire system from a mouse or touch screen input.

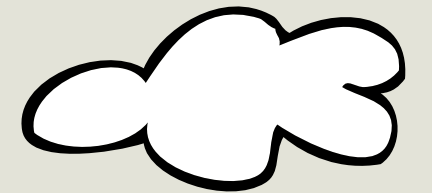
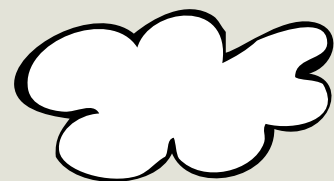

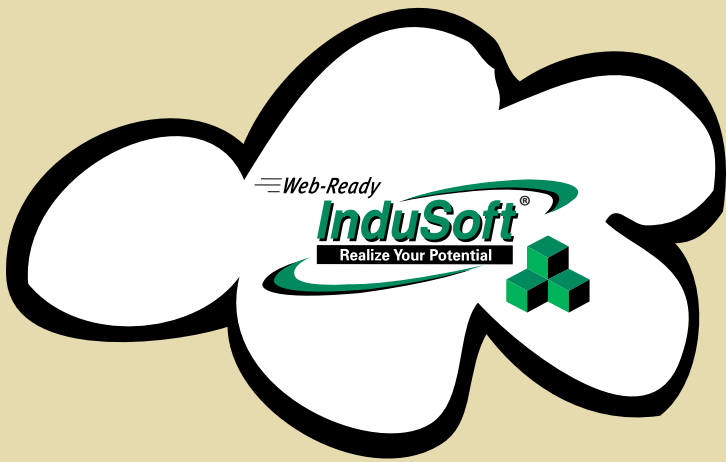

[indusoft.com](http://indusoft.com)  
[info@indusoft.com](mailto:info@indusoft.com)

